

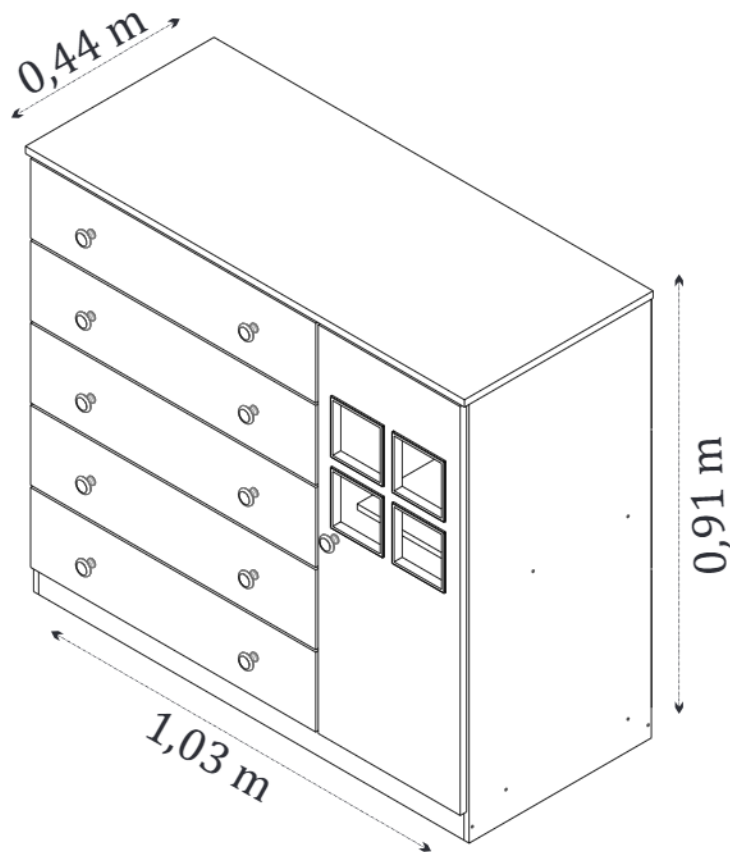

Qualidade para merecer você

MANUAL DE MONTAGEM - CÔMODA CAPRICO



CÔMODA CAPRICO CÓD. 19994

O fabricante se reserva ao direito de introduzir modificações técnicas em seus produtos, sem aviso prévio e sempre que julgar conveniente.

NECESSÁRIO:



Tcil Móveis LTDA
CNPJ 38.542.932/0001 39
Rodovia Ubá - Guidoal, s/n°Km 01
CEP- 36500-970



















IMPORTANTE: Antes da montagem deste produto, confira todo conteúdo de peças e componentes conforme indicado abaixo. No caso de falta de peças, entre imediatamente em contato com a loja onde o mesmo foi comprado para resolução do problema. A não observância desta instrução, exime o fabricante de quaisquer responsabilidades futuras.

LISTAGEM DE PEÇAS CÔMODA CAPRICHIO

MEDIDAS EM mm

CÓDIGO DA PEÇA	QUANT.	DESCRIÇÃO	COMPRIMENTO	LARGURA	PROFUNDIDADE	TIPO DE MATERIAL
19995	1	LATERAL DIREITA	900	420	12	MDP 12 MM
19996	1	LATERAL ESQUERDA	900	420	12	MDP 12 MM
19997	1	DIVISÃO	840	420	12	MDP 12 MM
19998	1	TAMPO	1036	445	15	MDP 15 MM
19999	1	BASE	420	327	12	MDP 12 MM
19956	1	PRATELEIRA LATERAL	355	327	12	MDP 12 MM
20000	1	PORTA	835	335	15	MDF 15 MM
19960	5	FRENTE GAVETA	673	163	15	MDF 15 MM
12990	10	LATERAL GAVETA	350	110	12	MDP 12MM
19961	5	TRASEIRO GAVETA	621	100	12	MDP 12MM
19962	5	FUNDO GAVETA	631	350	2,5	MDF 2,5 MM
20001	3	COSTA	1024	285	2,5	MDF 2,5 MM
19964	1	RODAPÉ FRONTAL	1004	60	15	MDP 15 MM
19965	1	RODAPÉ TRASEIRO	1004	60	15	MDP 15 MM
20002	1	TRAVESSA	390	60	15	MDP 15 MM

LISTAGEM DE FERRAGENS

Cód: 2471 (x36)  CAVILHA MADEIRA 6X25	Cód: 2466 (x8)  CANTONEIRA METAL 4 FUROS	Cód: 2464 (x10)  CANTONEIRA METAL 2 FUROS	Cód: 2457 (x2)  CALÇO DOBRADIÇA 26MM Nº 5	Cód: 2481 (x2)  DOBRADIÇA CURVA 26 MM	Cód: 8960 (x4)  APLIQUE PLÁSTICO QUADRADO 15MM
Cód: 2677 (x1)  GIZ CERA	Cód: 2520 (x11)  PARAFUSO FLANGEADO 3,5x25	Cód: 2505 (x14)  PARAFUSO CABEÇA CHATA 3,5x40	Cód: 2521 (x10)  PARAFUSO FLANGEADO 3,5x40	Cód: 7239 (x50)  PREGO C/CABEÇA 8x8	Cód: 10649 (x100)  PARAFUSO CABEÇA CHATA 3,5x10
Cód: 20088 (x1)  ACRÍLICO 300X290X2MM	Cód: 19501 (x5)  CORREDIÇA TELESCÓPICA 1 ESTÁGIO 350MM	Cód: 11063 (x6)  SAPATA L 1 FURO	Cód: 19456 (x11)  PUXADOR GRACE	Cód: 19973 (x2)  PERFIL H 25X17 PLÁSTICO 1024mm	Cód: 20036 (x6)  FITA DUPLA FACE
Cód: 14025 (x1)  ETIQUETA TILILIN					

